



Mid-range Swedish truck sleeper cab, flat roof

Conversion kit, 1/24

Warning!

Donor kit, Italeri Volvo Fh4, required!

Read carefully this instruction and please follow it during assembling, otherwise you could face problems with assembling the model.

Photo-etched parts have sharp edges, please be careful.

This model kit contains very small parts and is not suitable for children.

You can download this instruction as PDF-file at the our site at «Instructions» section.

Symbols:

 - glue parts;

 - do not glue parts;

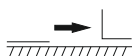
 - bend parts;

 - attention;

 - moving parts;

 - your choice;

 - cut;

Numbers of photo-etched parts

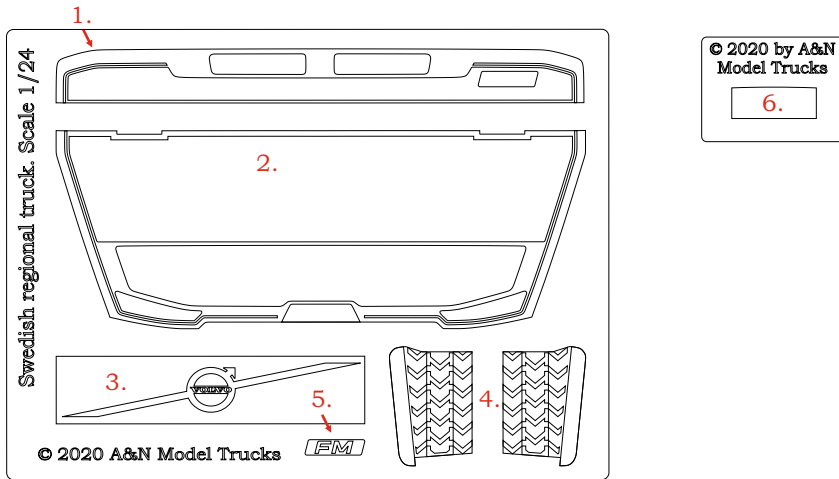

1. x2

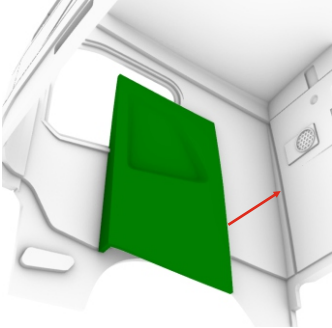

2.

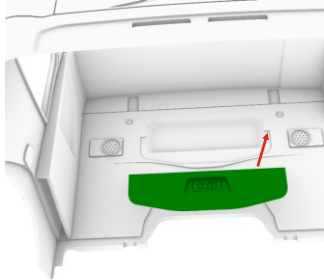

3.

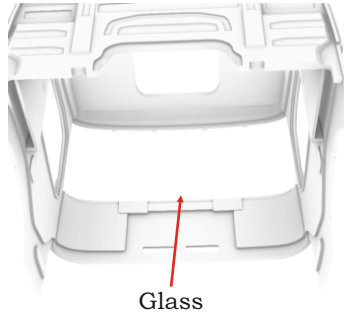

4. x2

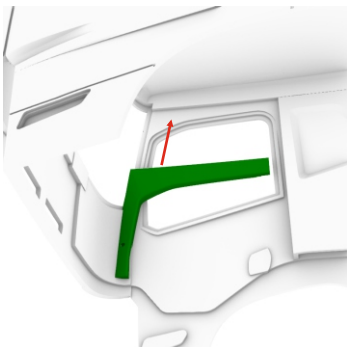

5.

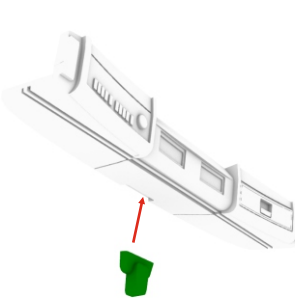

6.

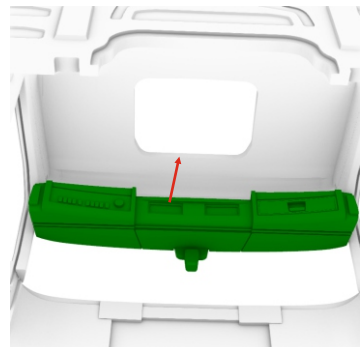

Mid-range Swedish truck, sleeper cab, flat roof. Conversion kit, 1/24

7.  x2

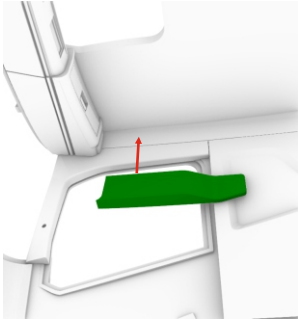

8. 

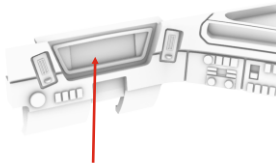

PE-part #6

9. 

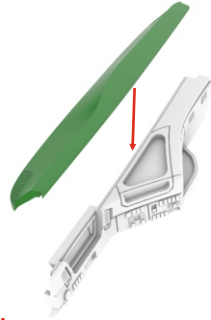

10. 

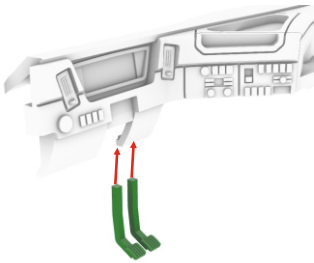

11. 

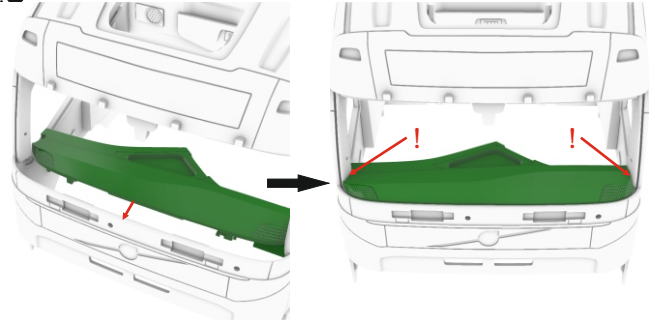

12.  x2

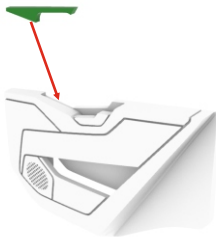

13.  x2

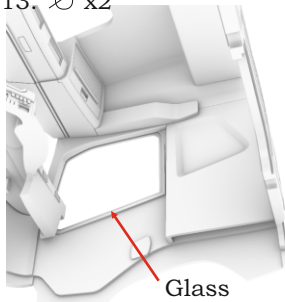

Glass

14.  x2

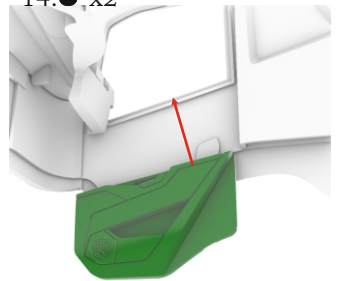

15.  x2

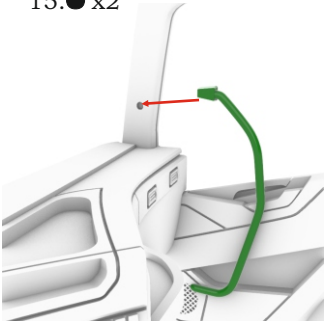

16. 

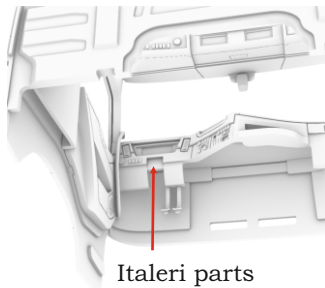

Italeri parts

17.  x2

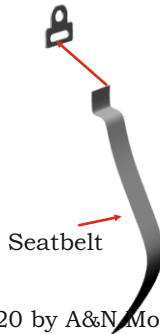

Seatbelt

Mid-range Swedish truck, sleeper cab, flat roof. Conversion kit, 1/24

18.  x2



19.  x2



20.  x2

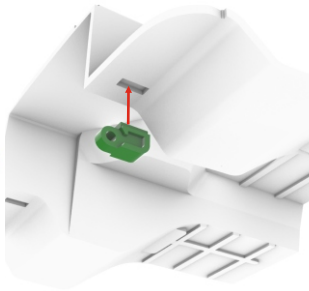

21. 

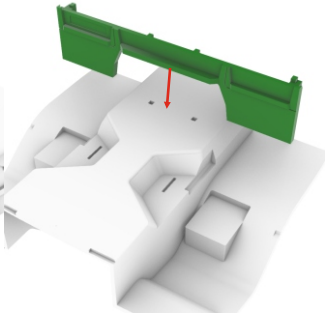

22. 

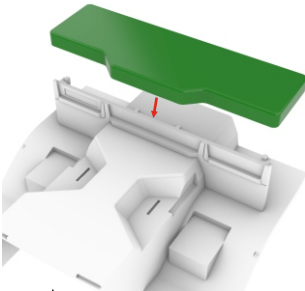

23. 

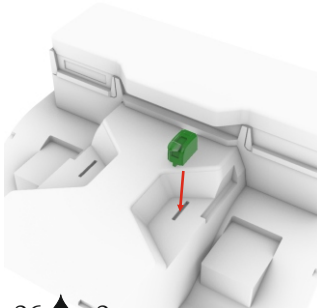

24. 

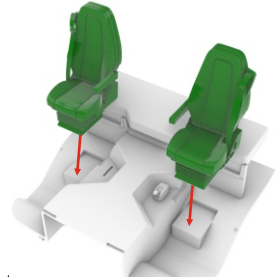

25. 

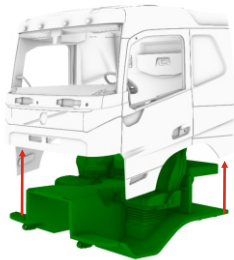

26.  x2

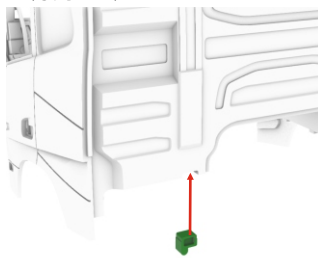

27. 

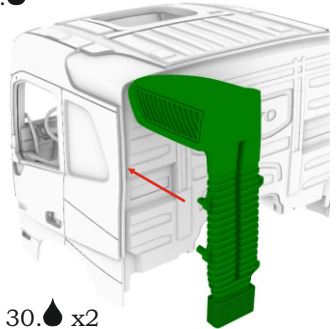

28.  x2

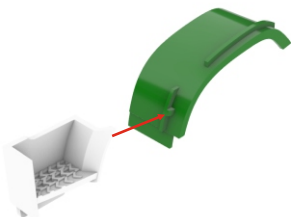

29.  x2

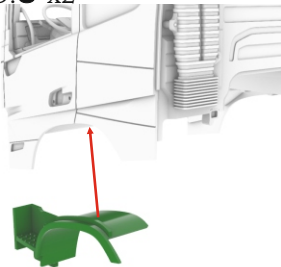

30.  x2

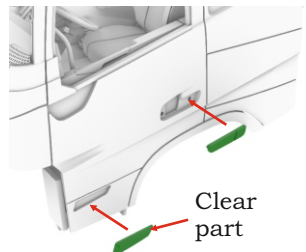

Mid-range Swedish truck, sleeper cab, flat roof. Conversion kit, 1/24

31. 

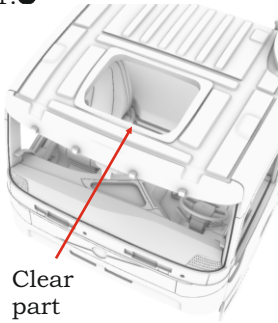

Clear part

32. 

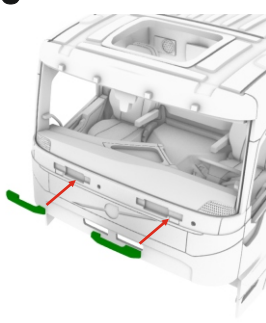

33. 

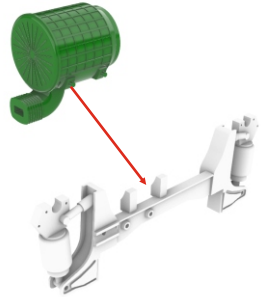

34. 

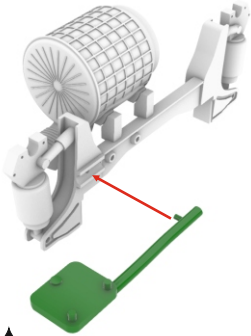

35. 

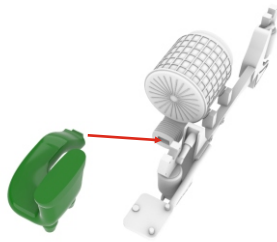

36. 

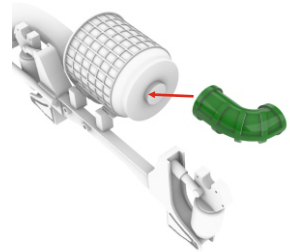

37. 

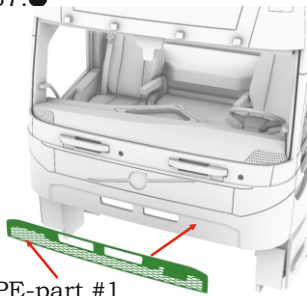

PE-part #1

40.  x2

38. 

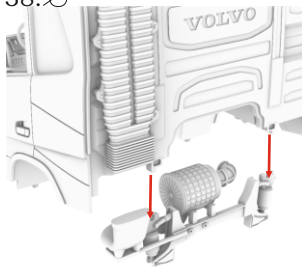

39. 

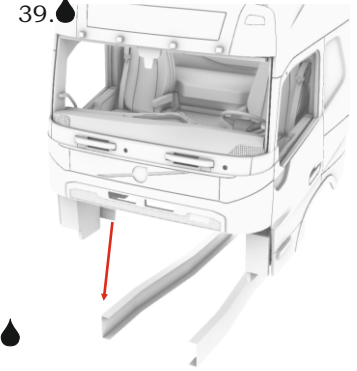

41. 

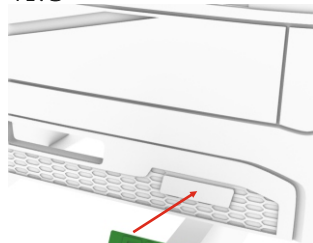

PE-part #5

42. 

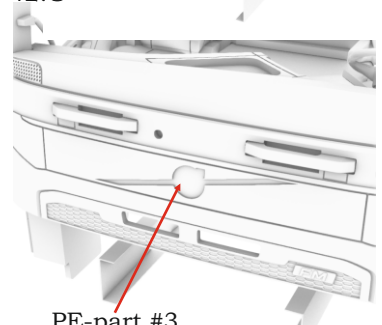

PE-part #3

Mid-range Swedish truck, sleeper cab, flat roof. Conversion kit, 1/24

43. 

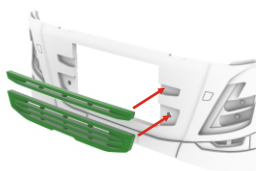

44. 

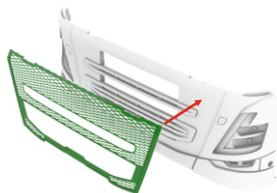

PE-part #2

45. 

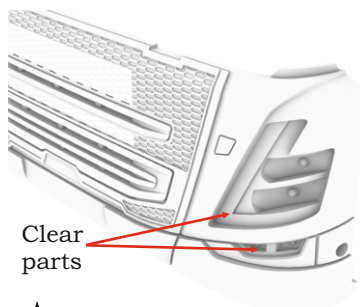

Clear parts

46.  x2

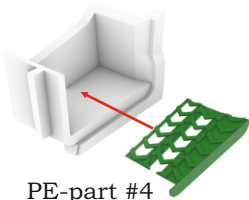

PE-part #4

47.  x2

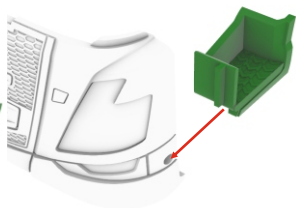

48. 

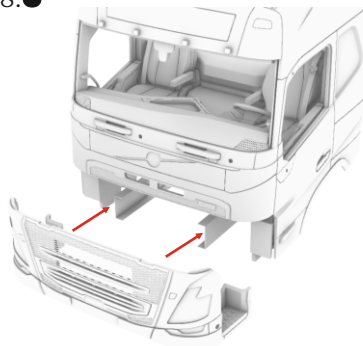

Made in Latvia

© 2020 by A&N Model Trucks